



LA CLOISON : 5 GAMMES

ADLOCK

- Inox
- Forme tubulaire
- Verre de 6 à 16 mm en standard
- Epaisseur plus importante sur demande

CLOISON ALU

- Aluminium
- Profils U
- Verre trempé de 10 et 12 mm
- Verre feuilleté 5-5.2 et 6-6.2

ELITE

- Bronze d'aluminium
- Forme rectangulaire
- Verre de 10 mm

ADLER VF

- Aluminium
- Profils U, un et deux départs
- Verre trempé ou non de 10 mm
- Verre feuilleté trempé ou non de 5-5.2

CAPSI ET ADSLIDE

- Cupro - aluminium / Inox
- charnière carrée - Tube rond
- Verre de 8 mm

Le mariage des tubes métalliques et du verre

Une cloison de 3m50 de haut, 7m de long et 4m de large. Elle est autoportante et raidie par une poutre carrée. L'entrée est coulissante.



- Une construction homogène, minimaliste et naturellement harmonieuse
- S'adapte sur tout type de cloison sans contrainte de forme, autoportante ou non
- La solution pour des constructions très élancées et lourdes
- Efficacité et résistance des points de serrage ADLOCK
- Réglages possibles facilitant la pose



Lien internet - fiche technique : <https://www.adler-sa.fr/fichetechnique/FT828A.HTM>
 - fiche commerciale : https://www.adler-sa.fr/fichetechnique/FTC_adler_adlock_poignees_serrure_integree_fr.htm



L'accompagnement de la conception jusqu'à la pose :

Composer sa cloison esthétique et fonctionnelle en combinant des modules élémentaires de parois fixes ou de blocs portes avec ou sans imposte.

Une technique de pose standardisée pour une qualité parfaitement maîtrisée.

ADLER SAS est concepteur et produit en France.

Son bureau d'étude est à votre service pour définir, étudier et valider tous vos projets de cloisons.

La garantie ADLER d'une solution élégante, fiable, performante et durable.

Une gamme inox complète pour des applications même hors standard.

SELECTIONS DE PIECES CLES POUR CONSTRUIRE UNE CLOISON

Connecteur d'angle à 1 point de fixation		73240K	x1
Connecteur glace / glace 180°		73243N	x1
Connecteur glace / glace articulé		73268Q	x1
Raidisseur ADSLIDE rond Penture pleine hauteur Sur mesure		69892V 73226U	x1 x1
Raidisseur orientable		69835J	x1
Poignée à serrure intégrée		70775F	x1
Coulissant suspendu : Roulement porteur		60018N	x2

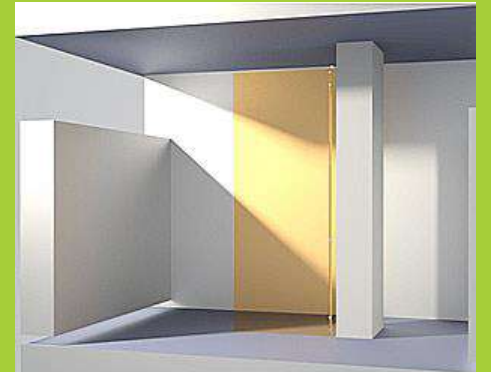
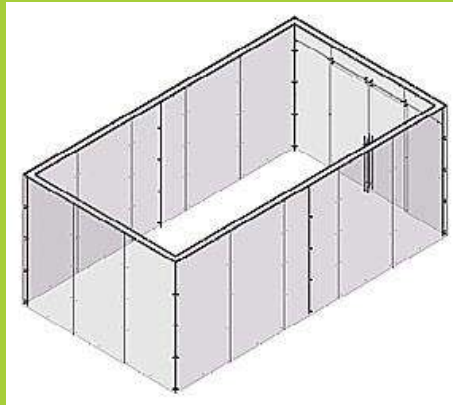
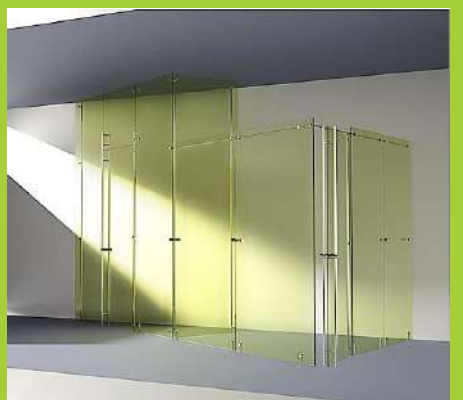
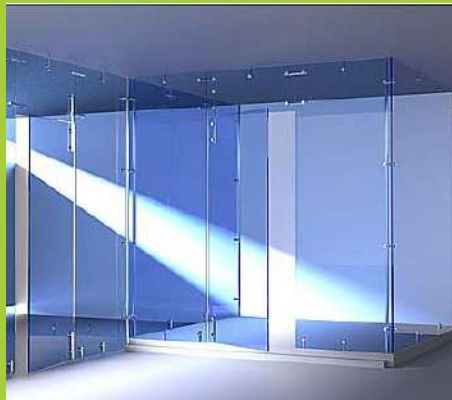
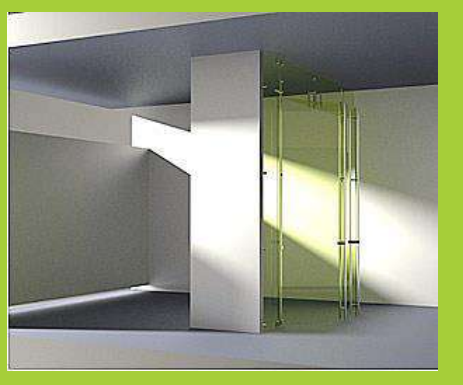

CLOISON ALU

ADLER propose un système complet de cloisons et d'encadrements de portes standard montés en feuillure. Adapté pour des cloisons et portes en verre de 10 et 12 mm et des portes en bois d'épaisseur 40 mm.

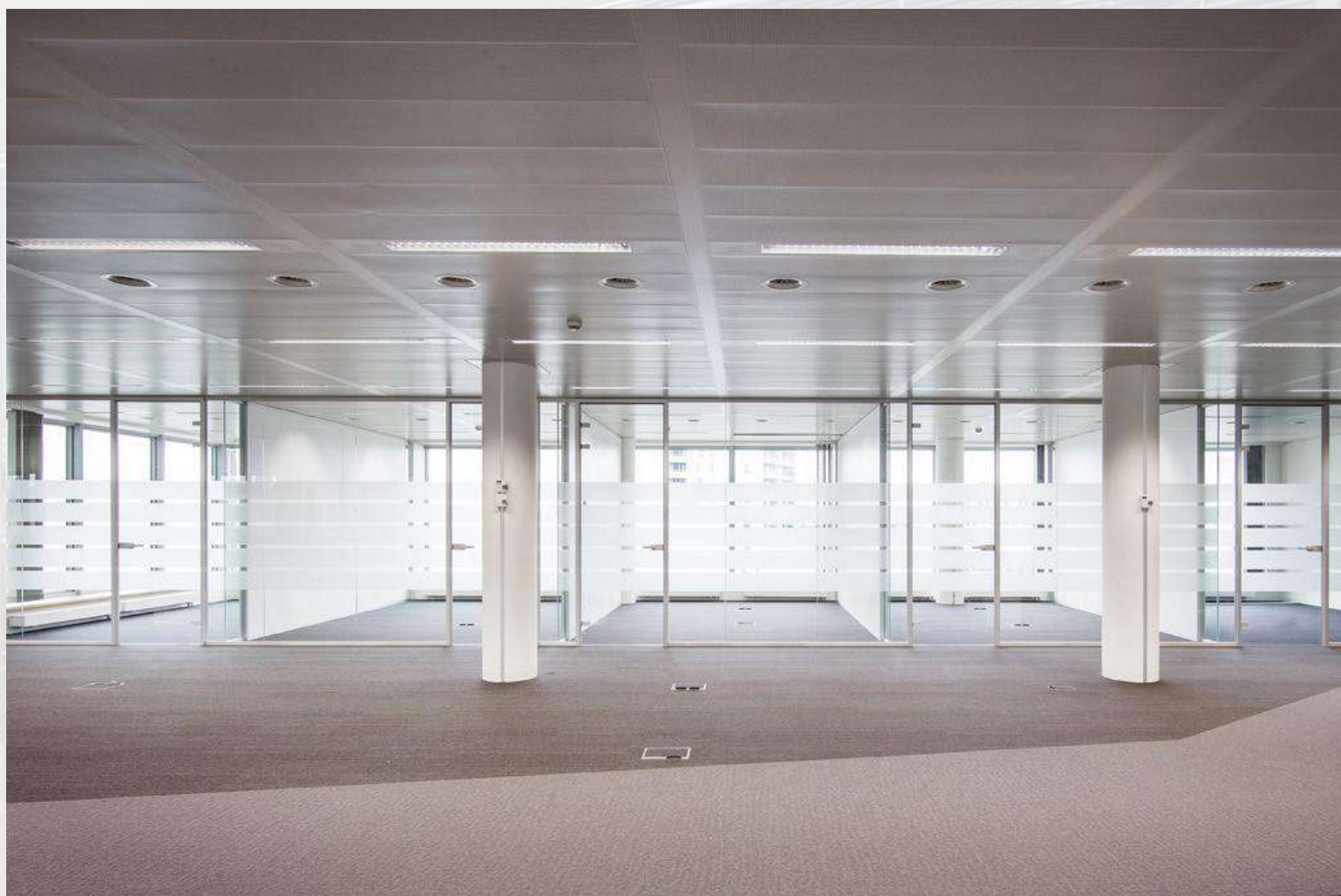

<https://www.adler-sa.fr/fichetechnique/FT841.HTM>



**Cloison en feuillure et porte non encadrée en châssis.
Une construction affinée et simplifiée.**



Une gamme aluminium en 3 décors et la possibilité de commander le laquage de votre choix. Vous réaliserez la plupart des constructions en verre de 10 ou 12 mm en standard et jusqu'à 88.2 sur demande. Autres finitions sur demande.

EXEMPLES DE PIÈCES		ANODISE NATUREL	INOX BROSSE	GRIS LAQUE RAL 9007	BRUT
Profil en U 25 x 30 x 6000 mm		73536R	73505G	73548D	73541W
Profil en U 25 X 35 x 6000 mm		73537S	73506H	-	-
Profil à parclose 30 x 25 x 6000 mm		73542X	73513Q	73549E	73544Z
Profil à clipser pour Parclose 6000 mm		73543Y	73514R	73550F	73545A
Profil cadre Porte 55 x 50 x 6500mm		73535Q	73504F	73551G	73540V
Paumelle pour porte x1		73177R	73176Q	-	Sur demande
Serrure béquille avec cylindre européen à blocage de pêne		73151N	73187B	-	Sur demande
Serrure béquille sans cylindre		73130Q	73189D	-	Sur demande
Paumelle pour porte x1		-	Inox mat 72853P	-	Inox poli 72852N
Paumelle pour porte x1		-	Inox mat 72855R	-	Inox poli 72854Q

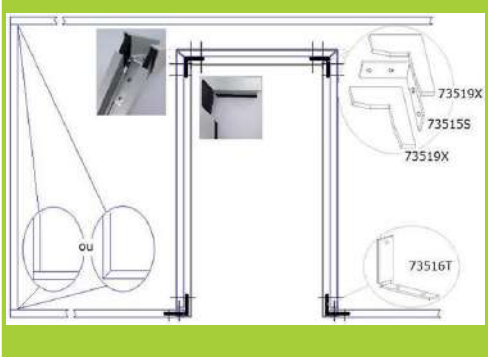
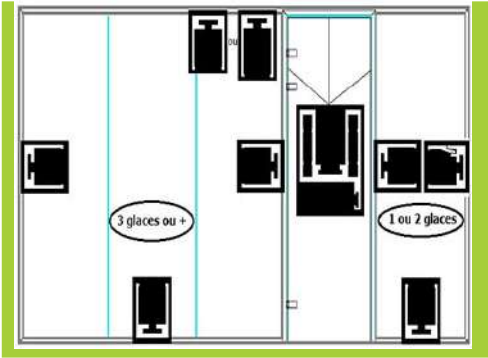

Cette gamme permet d'assembler tout type de façade avec imposte, contreventement, portes,..... en verre de 10 mm trempé, suivant le standard international.

Sur demande, **il est possible d'utiliser des verres jusqu'à 19 mm** et de réaliser une grande variété de finitions, laquages, patines et vernis.

Dans le cas de constructions particulières, possibilité de modifier des pièces existantes pour créer un nouvel assemblage inédit de composants assortis entre eux.



<https://www.adler-sa.fr/fichetechnique/Ft731.HTM>



Le verre non encadré, la cloison classique avec doubles portes.



Une gamme complète en bronze d'aluminium pour façade en verre trempé, un standard international.

Nous vous proposons 3 décors, anodisé naturel, chromé et or brossé.

Sur demande : décor inox brossé.

EXEMPLES DE PIECES		ANODISE NATUREL	CHROME	OR BROSSE	UV
Support d'imposte avec pivot à visser		73115Y	73117A	Sur demande	x1
Pince glace fixe latérale/imposte		73193J	Sur demande	Sur demande	x1
Penture haute axiale double action, axe 55 ou 65 mm		73102K	73104M	Sur demande	x1
Penture basse axiale double action, axe 55 ou 65 mm		73108R	73110T	Sur demande	x1
Poigné de milieu à béquille avec serrure cylindre européen		73151N	73153Q	73152P	x1
Poignée de milieu à béquille sans cylindre		73130Q	73132S	Sur demande	x1
Serrure de milieu anti-effraction avec protection cylindre		73142C	73144F	73143D	x1
Serrure d'angle anti-effraction, haute ou basse		73136W	73138Y	Sur demande	x1

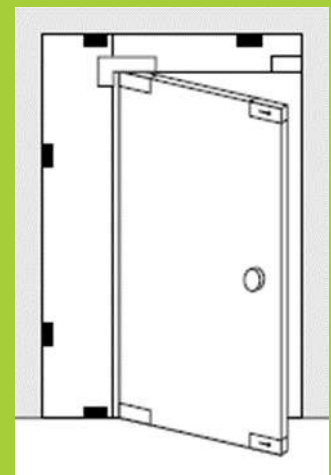
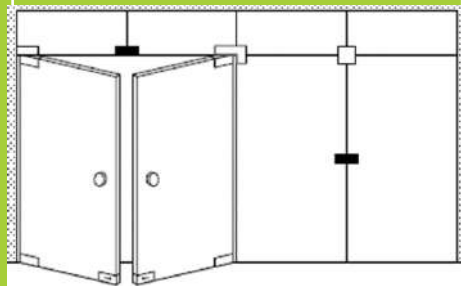
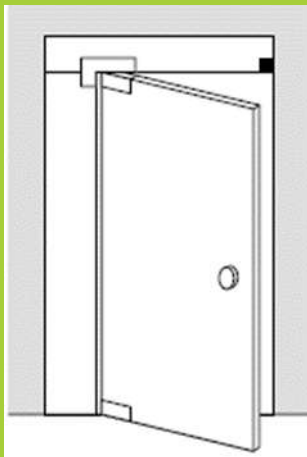
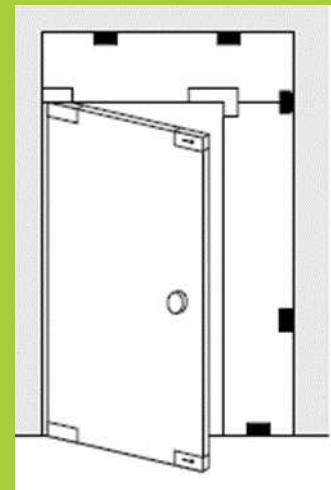
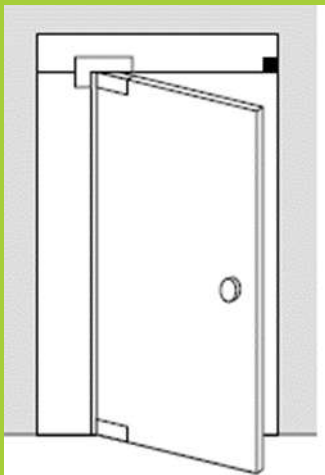
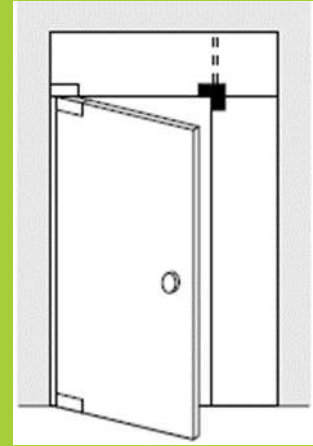
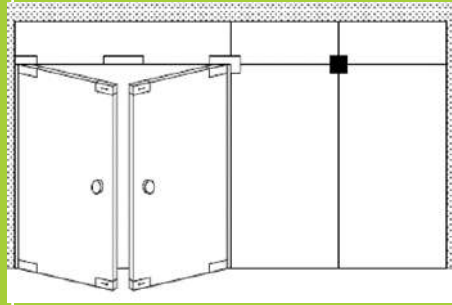
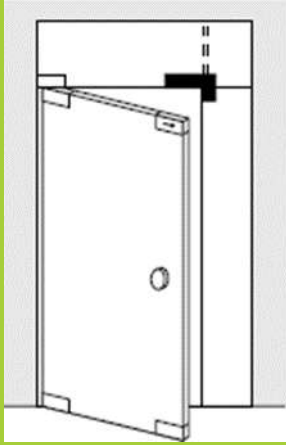

« CLOISON **ALU** » et « **ADLER VF** » :

Une combinaison étonnante !

Réaliser tous types de cloisons et portes, **même en verre feuilleté non trempé**.
Intéressant lorsqu'il est difficile d'approvisionner du verre trempé.

Simple pour la réalisation de parois en verre décoré (sérigraphie sur inserts plastiques d'un verre feuilleté ou colaminage d'un tissé...).

Des verres décorés peuvent être utilisés avec ADLER VF sans encadrement, aussi bien en parties fixe (cloison) que mobile (porte).



<https://www.adler-sa.fr/fichetechnique/FT851.htm>



Composer ...

Une construction élégante réalisée grâce à l'alliance parfaite de trois gammes de cloisons.



ADLER VF

DESIGNATION		ANODISE INOX BROSSE	POLI BRILLANT	BRUT
Profil simple avec joint sapin. 10 x 2450 mm		78069X	78070Y	Sur demande
Profil en L , double départ avec joint sapin 10 x 2450 mm		78072A	78073B	Sur demande
Charnière pleine hauteur recoupable jusqu'à 1m90		73285J	73282F	73270S
Profil de chant 10 x2 Autocollant joint Longueur 2m20		78050A	-	-

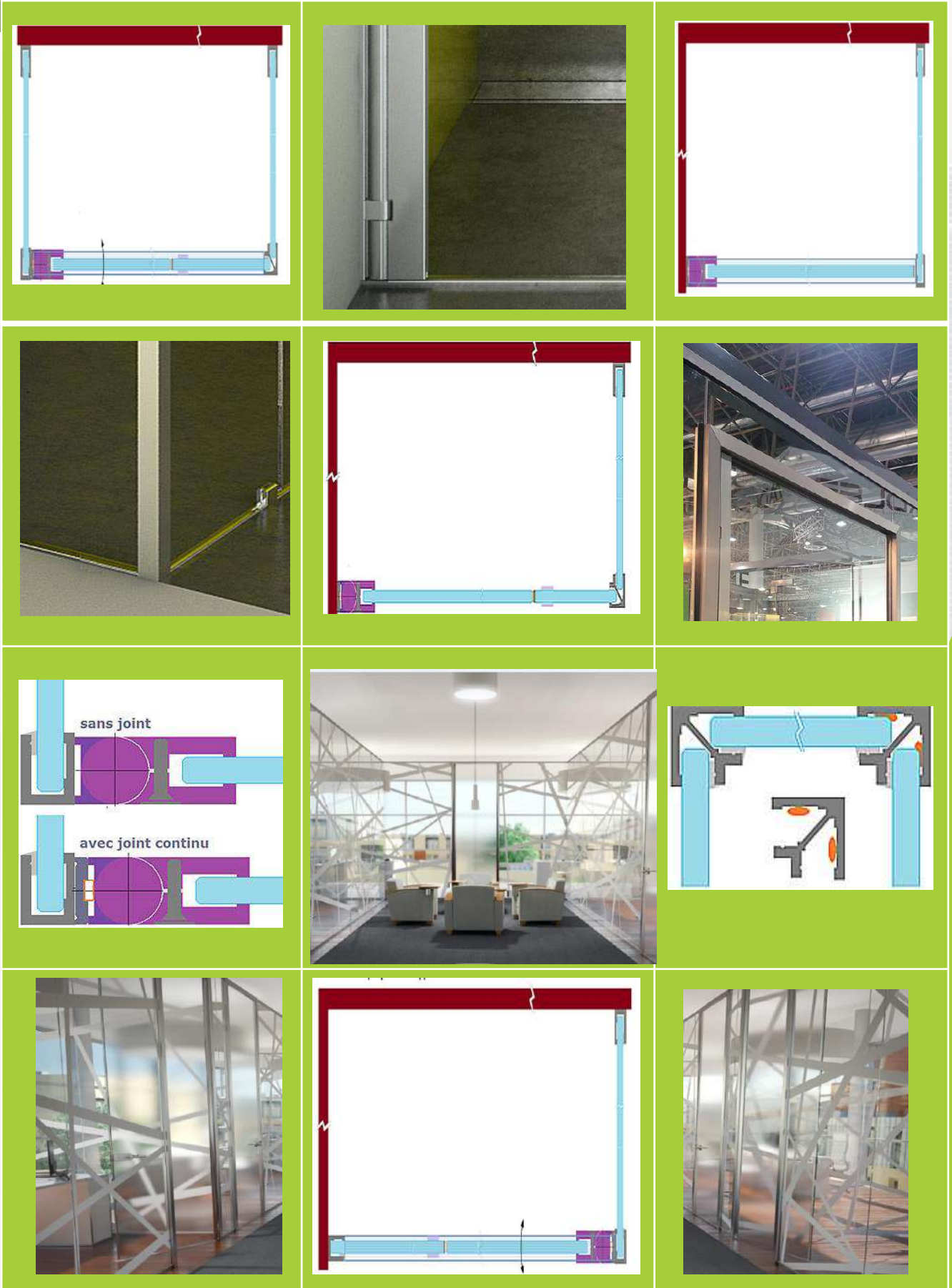

Une association équilibrée pour un aménagement optimisé !





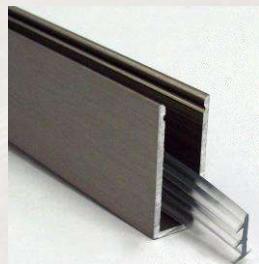
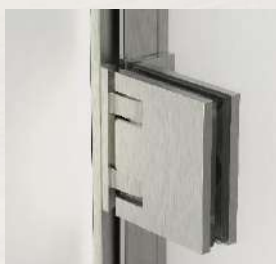

Une cloison simple et épurée qui a permis d'aménager une suite parentale devenue fonctionnelle et esthétique.



LA CLOISON **CAPSI**

Une gamme polyvalente et miniaturisée, adaptée pour la glace de 8 mm.

Une charnière de précision pour une fermeture au millimètre près dans une position de rappel réglable en continu.

DETAIL DE PIECES		CHROME BRILLANT	NICKEL BROSSE	DORE	UV
Charnière à rappel Reversi 57 x 57		64692T	64693U	64694V	X2
Méplat 38x5 aluminium		78004F	78005G	-	1m55
Profil aluminium de feuillure		78052C Poli brillant	78053D Anodisé fini inox	-	2m
Profil de seuil à intégrer dans le fond du profil		-	78080K 78079J Anodisé inox brossé	-	2m40 1m20

Cloisons coulissantes autoportées pour aménager différents espaces de salle de bain.



ALU ET INOX

La façade autoporteuse :

Une construction verre et métal mise en valeur par la pureté des lignes.
 Elle permet d'optimiser un espace sur mesure.
 Une conception simplifiée et très résistante grâce à des charges réparties.

EXEMPLES DE PIECES	Roulement	Profil + tube et point de serrage	Bouton cuvette
Inox Brossé			
Aluminium Brossé			
Aluminium poli			
Aluminium cuivré			
Aluminium anthracite			
Aluminium or			



ADLER

E-mail : admin1@adler-sa.com

Site : www.adler-sa.fr

Tél. : + 33 (0)1 60 03 62 00 • Fax : + 33 (0)1 60 03 62 49

Z.A. La Barogne • 9 Av. des 22 Arpents • 77230 Moussy le Neuf • France